

HIGH PRESSURE GEAR PUMP WP900X

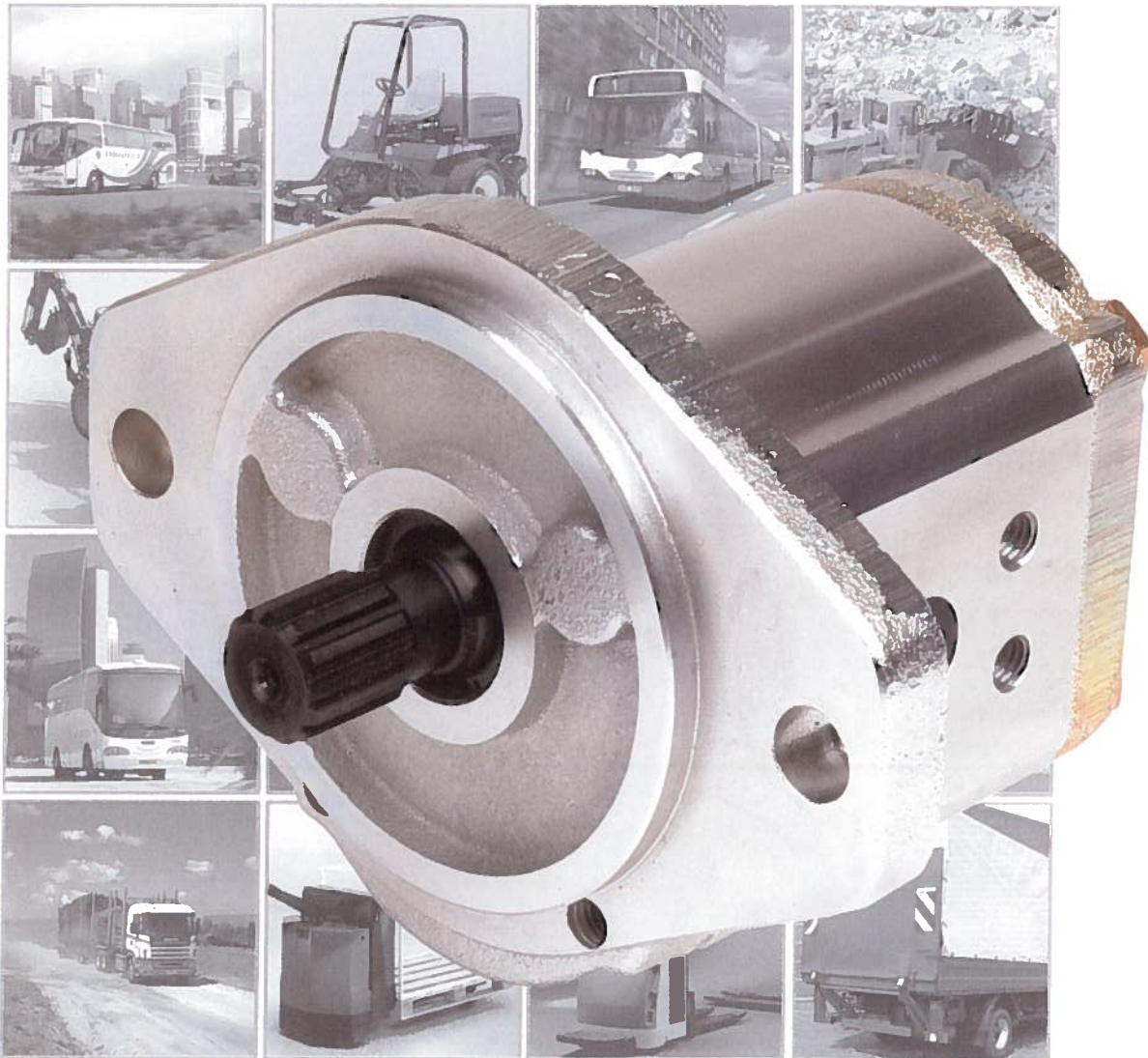

THE NEW D-DESIGN WITH HIGHER CAPABILITY

Since many years the W900 series pumps and motors from Haldex Hydraulic Systems are well known to the market for high performance and reliable duty.

WP900X is a development from the well known W900 series. The X-design enables higher pressure capability at displacements above 19 cc. Configurations are available with multiple pumps, larger and/or smaller pump ranges for optimizing the system, sealed sections to enable separate fluids and of course the typical Haldex integrated valve options.

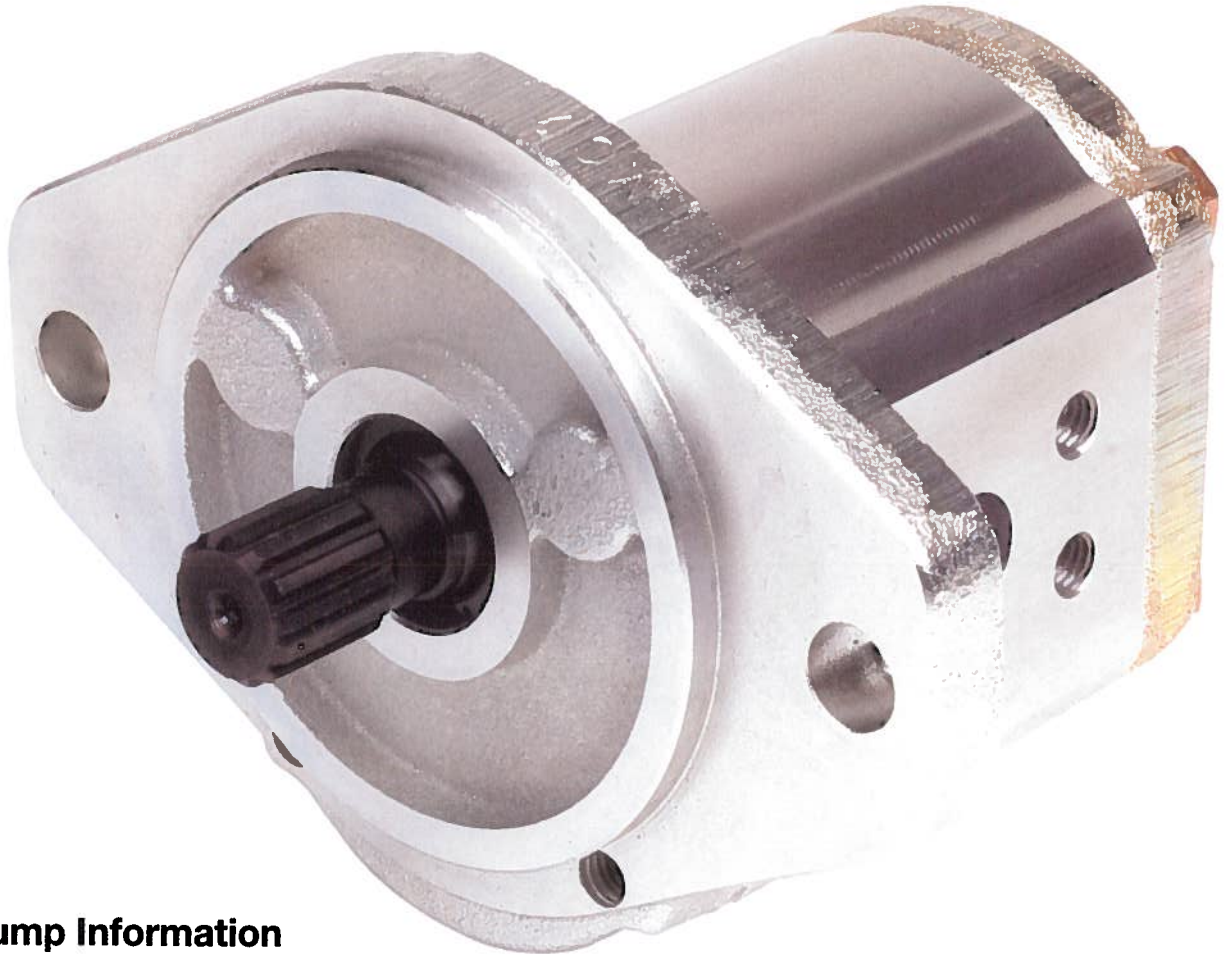

WP900X - Pump Information

Displacement range

- Displacements from 16 to 31cc

Special design features

- Increased pressure capability for higher displacements (> 19cc) compared to WP09A-Design
- SAE "A" and SAE "B" interfaces

Design options

- Multiple pumps available
- Combination with other pump ranges
- Double shaft seal
- In-between-sealed sections
- Seal material NBR, FKM optional
- Integrated valving

Technical Specification

Modelcode

Design Code	Seal material	Displacement	Rotation	Flange	Shaft	Ports	Valves	Specials
WP09X1	B	230	R	05	KA	146	N	N
1=Single pump B=NBR			CW				(NONE)	

Performance

Size Code	Displacement (cm ³ /rev)	Rated Pressure (bar)	Max Speed (rpm)	Dimensions (mm)	
				A	B
160	16cc	276	3000	110.4	53.4
190	19cc	276	3000	114.9	55.7
230	23cc	250	2800	120.8	58.6
270	27cc	230	2500	126.8	61.6
310	31cc	200	2200	132.8	64.6

Port Options (other ports on request)

Metric split flange per ISO/DIN 6162 (35 to 350 bar series):

European 4-bolt flange:

PORT CODE 146

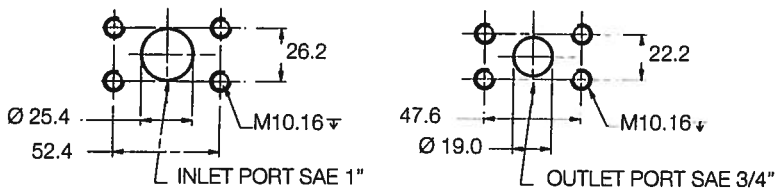

PORT CODE 151

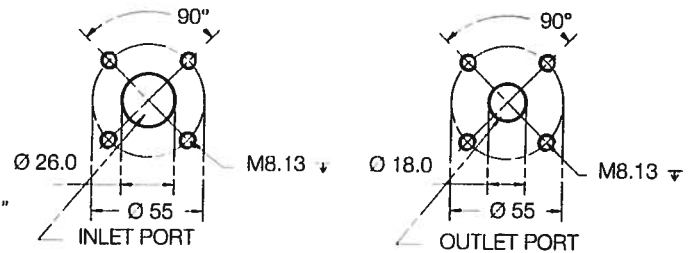

Shaft/flange options

FLANGE CODE 05 SAE B - 2 bolt

EXTERNAL INVOLUTE SPLINE 16/32
DP. 13 TEETH.
FLAT ROOT SIDE FIT
MAX. TORQUE 270 Nm

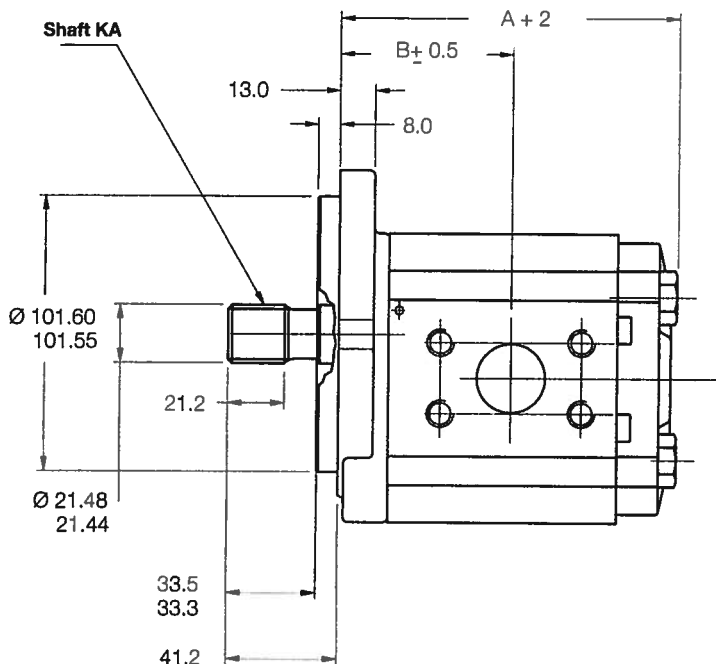

FLANGE CODE 03 SAE A 2 bolt

EXTERNAL INVOLUTE SPLINE
16/32 DP. 11 TEETH.
FLAT ROOT SIDE FIT
MAX. TORQUE 170 Nm

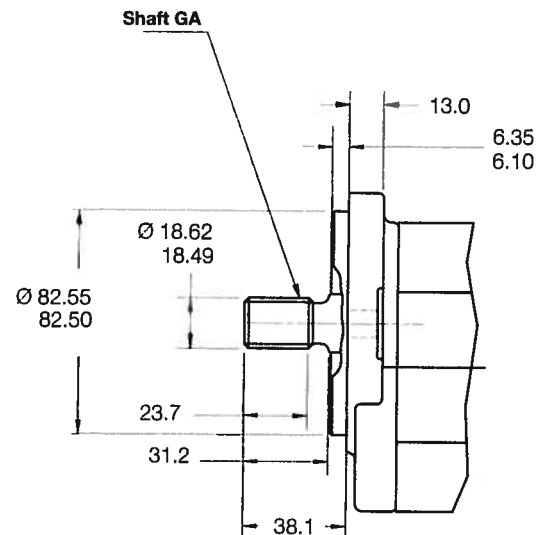

www.concentricAB.com



Haldex Hydraulic AB
 Tomtebodavägen 3
 SE-280 40 SK. FAGERHULT
 Sweden
 Tel: +46-433 324 00
 Fax: +46-433 305 46
info.hydraulics.eu@haldex.com

Haldex Hydraulic AB
 Ringvägen 3
 SE-280 40 SK. FAGERHULT
 Sweden
 Tel: +46-433 324 00
 Fax: +46-433 305 46
info.hydraulics.eu@haldex.com

Haldex Hydraulic GmbH
 Soligenweg 12
 Postfach 1507
 DE-95014 HOF
 Germany
 Tel: +49-9281 895-0
 Fax: +49-9281 87133
info.hydraulics.eu@haldex.com

Haldex Hydraulics Corp.
 2222 15th Street
 ROCKFORD, IL 61104
 USA
 Tel: +1-815 398 44 00
 Fax: +1-815 398 59 77
info.hydraulics.us@haldex.com

Haldex International Trading (Shanghai) Co. Ltd.
 16 A, Zhao Feng World Trade Building
 No. 369 Jiang Su Road, CN-200050
 SHANGHAI
 China
 Tel +86 21 5240 0338
 Fax +86 21 5240 0177
info.hydraulics.cn@haldex.com

 **CONCENTRIC** headquartered in Stockholm, Sweden, is a provider of proprietary and innovative solutions to the global vehicle industry, with focus on products in vehicles that enhance safety, environment and vehicle dynamics. Haldex is listed on the Stockholm Stock Exchange and has annual sales of nearly 8 billion SEK with 6,100 employees.

PRODUCT RANGE

HE Powerpacks
 12/24/48 VDC 0.3 – 4.5 kW and
 0.75 – 3 kW AC modular power packs

HB Powerpacks
 12/24 VDC compact powerpacks

Pressure Switches
 5 - 350 bar, connecting/
 disconnecting

HE Box Powerpacks
 12/24/48 VDC modular
 powerpacks in weatherproof
 boxes

W100 Hydraulic pumps
 0,5 - 2,0 cc 227 bar

W300 Hydraulic pumps
 0.8 – 5.7 cc 230 bar

W600 Hydraulic pumps
 3 – 12 cc 276 bar

WM600 Hydraulic motors
 3 – 12 cc 276 bar

W900 Hydraulic pumps
 5 – 31 cc/section 276 bar

WM900 Hydraulic motors
 5 - 31 cc/section 276 bar

WQ900 The quiet pumps
 5 - 23 cc/section 230 bar

FERRA Heavy duty pumps
 16 - 41 cc/section 276 bar

WP900D Hydraulic pumps
 16 - 31 cc/section 276 bar

W1500 Hydraulic pumps
 19 - 50 cc/section 276 bar

WM1500 Hydraulic motors
 19 - 50 cc/section 276 bar

GPA Internal Gear pumps
 1.7 – 63 cc/section 100 bar

GC Hydraulic pumps
 1.06 – 11.65 cc/section 275 bar

II-Stage Hydraulic pumps
 4.2 – 22.8 cc/section 275 bar

Rotary Flow Dividers
 3.8 – 13.3 cc/section 300 bar

Q20/Q30 (LS) Hydraulic pumps
 23 – 161 cc/section 275 bar

Transmission pumps

Closed Crankcase Ventilation

EGR pumps

Fuel pumps